

MANUAL

EG



SCOTEX[®]

BY SXT



H10

| | |
|---|--|
| <p>Modell SCOTEX H10</p> |  <p>Download Current manual</p> |
| <p>Manual - Version SCOTEX_MAH10_V1.3</p> | |

| | Page |
|--------------------------|------|
| Scope of delivery | 3 |
| Technical data | 5 |
| Important information | 6 |
| Before riding | 8 |
| Vehicle parts | 10 |
| Handlebar controls | 11 |
| Folding up | 12 |
| Folding | 13 |
| Brake cable assembly | 14 |
| Serial number | 16 |
| Before using the battery | 17 |
| Charging the battery | 18 |
| Driving | 24 |
| Maintenance and care | 26 |
| Error code | 28 |
| Recycling the battery | 29 |
| Warranty | 30 |
| Customer service/repair | 31 |



Elektroscooter

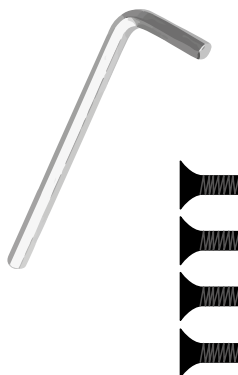

Inbusschlüssel und Inbusschrauben.



Kennzeichenhalterung



Ladegerät



Display



Handbuch

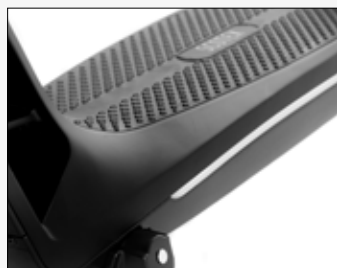

Street-legal: yes

Max. Range (in km - at 22°C / load 70 kg): 30

Max. Speed (in km/h): 20

Rated motor power (in watts): 350

Drive type: Brushless hub motor

Max. load (in kg): 100

Length, width, height (in cm): 108 x 49 x 119

Length, width, height / folded (in cm): 108 x 49 x 48

Tyre size in inches: 8.5

Weight (incl. battery) in kg: 14.8

Battery capacity in Ah: 10.4

Battery capacity in Wh: 270

Battery type: Lithium

Battery removable for charging: no

Charger: 42V 2A

Max. Charging time (in hours): 3,5

Brake system: drum brake front, electromagnetic rear

Tyres: 8.5 x 2 inch pneumatic tyres with inner tube

Vehicle frame: Magnesium alloy

Handlebar height (in cm): 114

Scope of delivery: Electric scooter, charger, manual

Lighting: LED front & rear

Foldable: yes

Operation: Thumb throttle

KERS (recuperation): yes



For safe and proper use, carefully read the instructions for use and other documents accompanying the product and keep them for later use! The current version of the operating manual can be found with the product on our homepage www.scotex.de or via the QR code on the cover.

Why should this manual be read in detail!

This manual has been written to help you, the buyer, quickly and easily understand how to use and maintain the **SCOTEX H10** accurately & safely. It is important that you understand all the points and features of your new **SCOTEX H10** so that you can enjoy riding your new electric scooter from the very first minute. For the first ride, you should select a large open area to familiarize yourself with the riding habits and features of the scooter. The **SCOTEX H10** requires a short running-in and braking phase related to all moving parts until this has taken your exact position perfectly. Before riding, always make sure that the folding mechanism is correctly engaged and the safety lever is flipped.

The use of the electric scooter involves dangers. Various causes can lead to the failure of individual components through no fault of the manufacturer. Like other electric vehicles, the electric scooter is designed for locomotion - this automatically involves the risk of losing control while riding, falling or getting into dangerous situations that could not be avoided by training, practice or instruction. In such cases, despite the use of protective equipment or other precautions, you may be injured or, in the worst case, killed. **USE AT YOUR OWN RISK. USE COMMON SENSE.** This manual contains various warnings and safety precautions concerning the consequences of improper maintenance and care or improper use. Any accident could result in serious injury or, in the worst case, death - we do not repeat this warning regarding possible injury or, in the worst case, death at every point where such a warning is given.

1. The **SCOTEX H10** may only be driven from 14 years. Never use the vehicle with 2 people at the same time.
2. Register the scooter with an insurance company before driving it on the road for the first time! The insurance license plate must be installed on the license plate holder.
3. Always check the vehicle before driving it. Regular maintenance and care minimize the risk of damage, accidents and possible injuries.
4. Always wear suitable protective equipment such as an approved helmet with chin strap. A helmet may also be required by law in your area. We also recommend elbow and knee protectors, long-sleeved outerwear, long pants and gloves. Always wear sturdy footwear such as lace-up athletic shoes with rubber soles for a firm grip. Never ride the scooter barefoot or in sandals and keep laces closed and away from wheels/motor.
5. Practice riding in a closed off open area.
6. This scooter is not suitable for jumps, stunts or similar - likewise avoid riding with only one hand on the handlebars. Always keep both feet on the footboard.
7. Do not drive the scooter up or down any steps / stairs larger than 3 cm - this could irrevocably damage the vehicle due to the shocks and vibrations that occur.
8. The maximum speed is 20 km/h. Avoid using the scooter at night as visibility is much worse than during the day. If this is unavoidable, we recommend not to exceed a speed of 15 km/h and to switch on the lights.
9. Do not use the scooter at temperatures below 0°C.
10. Drive very slowly and carefully or best get down from the scooter if you find bad road conditions.
11. Do not use the scooter on oily or icy surfaces.

**DISREGARDING THE ABOVE INSTRUCTIONS AND
DISREGARDING NORMAL COMMON SENSE
INCREASES THE RISK OF SERIOUS INJURY.**



Mechanical safety check:

Before using the **SCOTEX H10**: Perform a visual inspection for any loose screws and other parts. Make sure everything is in place and no parts are missing or showing severe wear. If you are unsure, be sure to contact your dealer or technical support immediately!

Preparation

1. search for suitable terrain
2. unfold scooter according to instructions (p.12)

Driving off

Press the POWER  button to switch on the scooter.

2. Place one foot on the footboard and keep the other foot on the ground.
3. slowly and carefully press down the right thumb throttle - the scooter will immediately move slowly forward. Take the second foot off the ground and place it on the footboard as well. The more the thumb throttle is pressed, the more the scooter accelerates and the faster the ride.

Braking

1. The left hand brake operates the brake on the rear wheel
2. The e-scooter has a brake lever attached to the right handle, which can be used to operate the drum brake on the front wheel.

Kick start function

This function is for your safety. When the scooter is to be used, you should kick / propel it with one foot to start the scooter moving and then press the thumb throttle first and the scooter will start moving with motor power. This protects the motor and prevents the scooter from accidentally starting to move if the throttle grip is accidentally pressed.

Battery and charge

The **SCOTEX H10** is equipped with a special lithium polymer battery and a special smart charger. These accessories, supplied with each scooter, have their own number. Please do not use other brands of chargers.

If the battery or charger is damaged as a result, the warranty will be voided.

Battery

When you get the electric scooter for the first time, please charge the battery fully before using it. The battery can be charged at any time, please make sure the battery is powered.

Attention: do not use other brands battery, they will not work with **SCOTEX H10**.

Please charge the battery every three months when you are not using the scooter.

Immersion in water, collision and other abnormal factors will cause battery damage, which is not covered by warranty.

Charger

The company provides a charger that has a charge protection function. When the battery is 100% charged, the charger will automatically stop charging.

Submersion in water, collisions and other abnormal factors will cause damage to the charger that is not covered by the warranty.

Quick instructions for charging the electric scooter

1. Connect the charging plug to the power outlet first. The LED will turn **green**.
2. open the protective rubber cover of the charging hole, insert the plug of the charger into the charging hole. It means it is charging when the charging indicator light is **red**, the charging indicator light is **green** when the battery is fully charged.



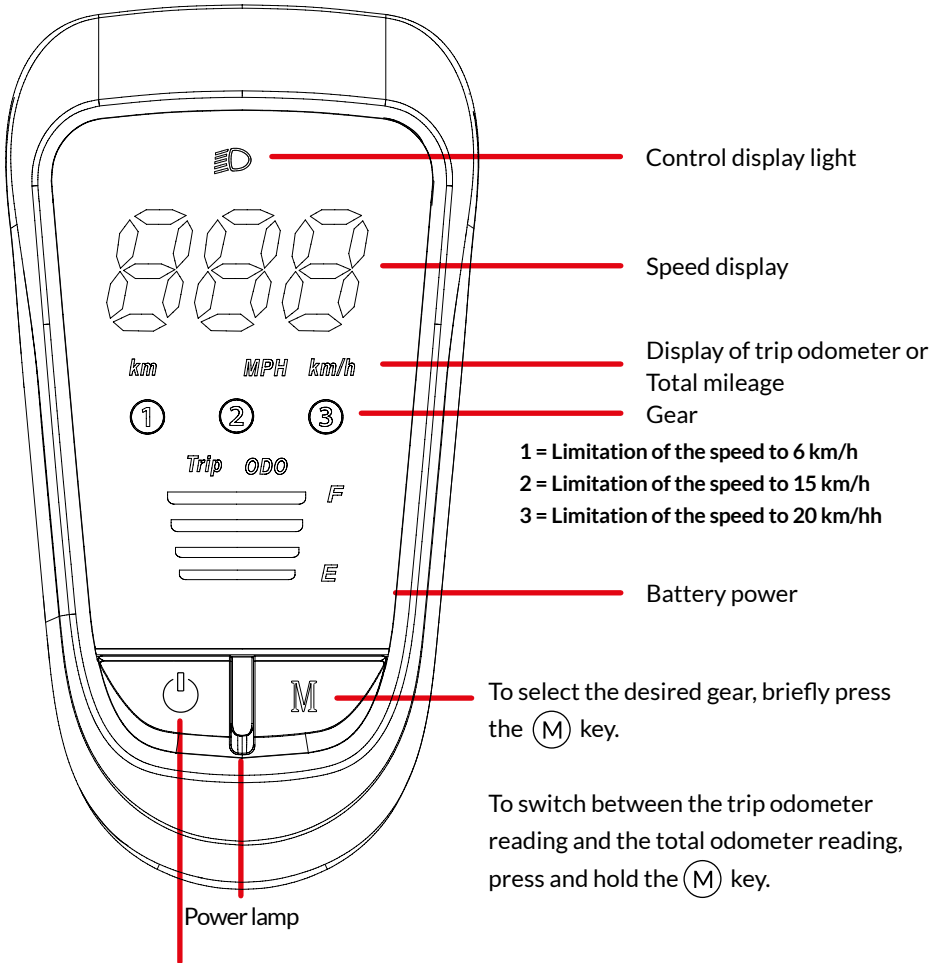

Press and hold the power switch (⏻) to switch the scooter on or off.

To switch the light (☹) on or off, briefly press the power key (⏻).

1. Place the scooter stably on the ground and fold up the handlebar - then use the locking lever to secure the folding mechanism (Fig. **1**).
2. Next, connect the two plug contacts Fig. **2** and then fasten the handlebar with the 4 supplied Allen screws Fig. **3**. Please ensure that the screws are tightened evenly.
3. Now position the brake lever and bell correctly and tighten the screws firmly.

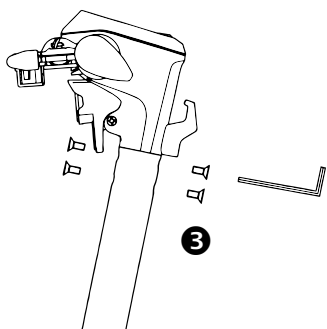

Construction video

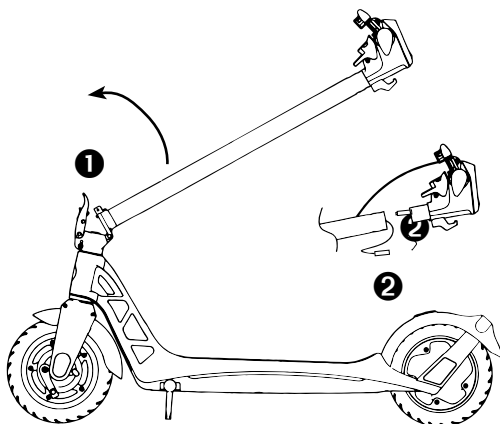

First, push the small red lever up Fig. **1** then you can flip the locking lever Fig. **2** to the left and tilt the handlebar down with the handlebar.

As a last step, you only need to hook the hook on the handlebar into the tab provided for this purpose on the rear mudguard Fig. **3**.

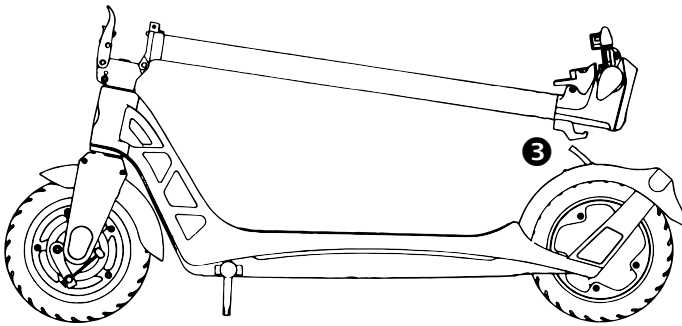
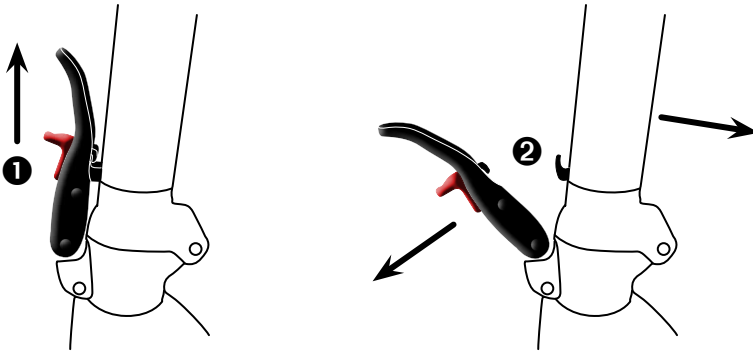



1. After you have mounted the handlebar, first turn the front brake adjustment screw counter-clockwise until it is flush with the thread.



2. Now hook the brake cable into the brake lever.



3. Now pull the brake cable along the recess on the brake lever until it fits into the guide at the end of the brake lever.





4. Now adjust the adjustment screw of the front brake so that no grinding noise can be heard when turning the wheel.



5. Now check the brake for proper function.

Make a note of the vehicle identification number of your e-scooter. Keep it in a safe place.

Each Scotex scooter has an individual number. This can be used to uniquely identify your vehicle, e.g. in the event of theft.

This is how you can find the vehicle identification number (VIN):

The number is located on the front right of the frame.



Before you use the scooter, please make sure that it is the original battery of the vehicle. Please do not use a battery of other brands or other models. Check that the battery is in good condition externally, and make sure there is no damage, leakage, heat generation, water ingress, smoke and other obvious phenomena. In order to ensure the safety of transportation, the electrical quantity of the batteries from the factory is about 30%. It is a normal phenomenon that when first used, there is a small amount of electricity or none at all, which is due to the consumption of electricity by transportation and storage. Please do not worry and just charge it according to the charging instructions.

Do not disassemble the used batteries on your own and return them to the appropriate departments for recycling and disposal.

At low temperatures, the available capacity of the battery is attenuated to varying degrees. Specific reference degrees are as follows: Available capacity is 70% at -10°C , 85% at 0°C , and 100% at 25°C . If you notice that the battery smells, heats up, deforms, and other abnormal conditions, stop using it immediately, stay away from the battery, and contact the service department.

A battery is not a part that can be repaired by the user. In case of abnormal appearance, please contact the after-sales service department for maintenance. Users who disassemble the battery without permission will not benefit from the warranty, and unauthorized disassembly may cause the battery to generate heat, smoke, fire or explosion.

1. First connect the charger to a standard power outlet, then connect the charger cable to your scooter. When everything is connected, the red indicator on the charger will light up. The battery is full when the indicator light changes from **red** to **green**. At this time, you can remove the charger and replace the protective cover.

2. Standard charging time:

The charging time is approximately 3-5 hours. The scooter should be charged in a well-ventilated room at a normal average temper.

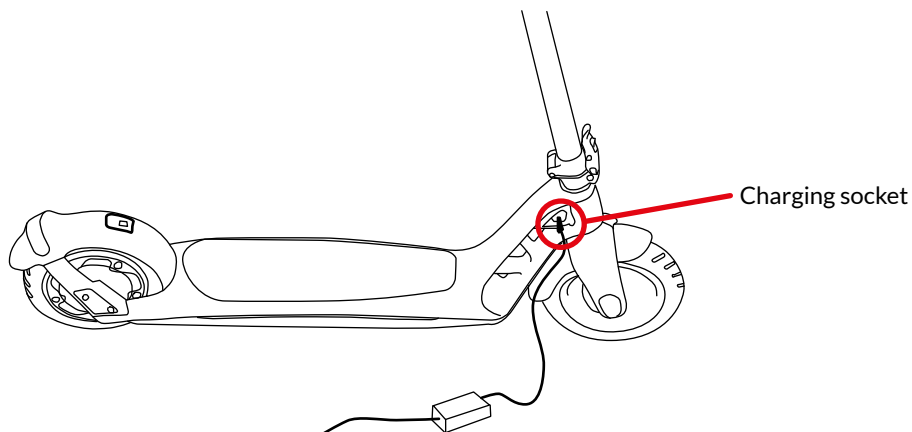

Charging information for lithium batteries:

Lithium batteries should never be deep discharged, this will irreparably damage the lithium cells. All lithium batteries should (if possible) always be stored at medium charge. If a battery is not needed for a long time, please do not fully charge it beforehand - this puts the lithium cells in unnecessary „stress“ which can lead to a shortened life span in the long run. If you have a choice when using the battery, we recommend in principle not to fully charge it, but always to use it in the medium voltage range. Of course, the battery can be fully charged to drive long distances, for example - it's just technically best for a lithium battery not to do this in order to really get the maximum performance and lifespan out of the battery.

Lithium battery life is expressed in charge cycles. Don't think you are „wasting“ many charge cycles by recharging the lithium battery more often even though it is not „drained“ - this is completely wrong! The indicated lifetime in charging cycles means so-called full cycles. This means that if you discharge your battery 50% and then fully charge it again, this corresponds to ½ charging cycle. Charging twice corresponds to one full cycle. We recommend recharging a lithium battery at 25 % residual charge up to approx. 75 % charge level. For long distances, however, the battery can of course be fully charged - see above.

During wintertime or long storage of vehicles with lithium batteries, it is imperative to recharge them at least once a month to approx. 60 %.

For lithium batteries, use only the chargers approved and recommended by the manufacturer. Charging with too high a charging current in order to be able to charge faster can irreparably damage the lithium cells and, in the worst case, even lead to a fire.



Please keep the battery from getting wet with water, drinks and corrosive liquids.



Please keep the battery from heat sources, open fire, flammable and explosive gases (liquids).



Please use the original charger matching the battery for charging and do not use chargers of other brands or models.



Do not charge for longer than 12 hours so as not to affect the battery life.



Please do not use the battery at -10°C -45°C .



Please avoid the penetration of metallic things into the battery compartment.

In the initial stage of charging, the amount of current increases rapidly, but in the next stage, it increases slowly; this is the procedure set for charging safety and is a normal phenomenon.

During charging in winter, when the outdoor temperature is low and the ambient temperature is below 0° C, the charging process of the battery will be interrupted, which is a normal phenomenon. Please place the battery in a suitable ambient temperature for charging to ensure the charging effect.

During charging, some chargers with aluminum case have temperature rise effect and higher surface temperature, which is normal. Please do not use them. Please be careful to avoid children's touch.

Notes on the use of the charger

The charger can only be used indoors. Charging under hot sun or high temperature is strictly prohibited. When charging, you should first insert the charger's power plug into the Power socket in the wall, and only then insert the plug into the scooter's charging socket. When the vehicle is fully charged, you should first disconnect the power supply and then unplug the battery of scooter. When the **green** light is on, the power supply must be disconnected in time. Do not connect the charger to the mains for a long period of time without charging. If any abnormality or strange smell appears in the indicator light or overheating of the charger case during charging, stop charging immediately and repair or replace the charger. It is prohibited to disassemble or replace the charger components by yourself. The charger must be replaced to match the battery model.

Precautions for the battery

Make sure that the battery was exhausted the first time you use it, then charge it and repeat this process two or three times to make sure that the actual capacity of the battery matches the capacity shown on the display.

Make sure that the battery power is not less than 20% and recharge it in time to prolong the battery life.

In everyday life, it is recommended to drive at a medium speed. Start slowly and operate the throttle to accelerate gradually, which can also extend the battery life.

As the battery life increases, there will be a discrepancy between the actual capacity of the battery and the capacity shown on the display. Please fully discharge and charge the battery regularly (not longer than 3 months). The internal battery cell and intelligent system can calibrate the power amount automatically to improve your experience.

It is recommended to check the battery power plug every two months for carbon deposits and oxidation blackening on the contact tongue.

Do not place the battery in the rain, rinse it, or even soak it in water. The entire battery compartment must not be soaked in water, otherwise water will enter the battery, causing an internal short circuit and permanent battery failure. In the above case, it is strictly prohibited to recharge the whole vehicle or battery, otherwise it will cause fire, combustion and explosion. Please transfer the battery to the designated network for maintenance immediately.

1. The safety guard/splash guard for the charging port should be replaced after the scooter has been charged.
2. The scooter should be kept out of the reach of children during charging. children during the charging process.
3. Under no circumstances should a charger other than the one supplied be used to charge the scooter. In addition, the supplied charger should only be used for this scooter.
4. a charger that is not working should not be disassembled under any circumstances. disassembled. Please contact the dealer.
5. the battery should not be stored near fire or corrosive environment, as it is highly flammable.
6. the label on the battery should not be smeared or removed.
7. the battery compartment should not be opened to avoid damaging parts inside the battery. If the battery does not charge, please contact the dealer.
8. To keep the battery in good condition, it should be charged at regular intervals every 20-30 days.

Warning:

Do not connect the charger to the scooter if the charging cable or charging port is wet.

Remark:

Typically, a fully charged battery in standby mode should last for 120-180 days, a low charged battery for 30-60 days. Please remember to charge the battery after each use. If the battery is completely discharged, it may damage the battery.



The scooter needs a push to start (kick-start function).

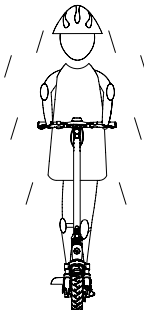

Do not drive the scooter in the rain.

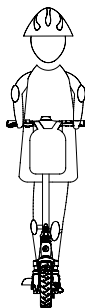

Do not hang backpacks or other objects on the handlebars when riding the scooter.

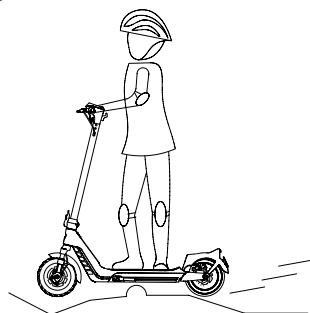

Do not drive at high speed on bumpy roads and do not drive against steps higher than 2 cm.



Do not step or stand on the rear mudguard while riding.

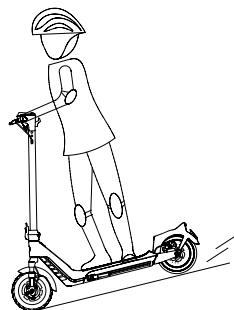

Do not accelerate at full throttle when driving downhill.

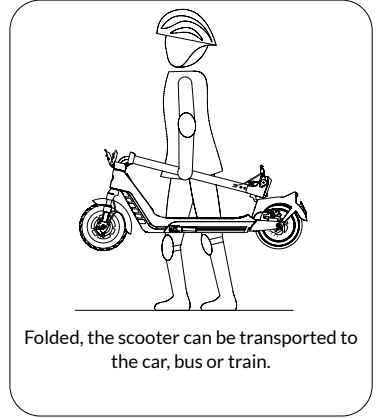
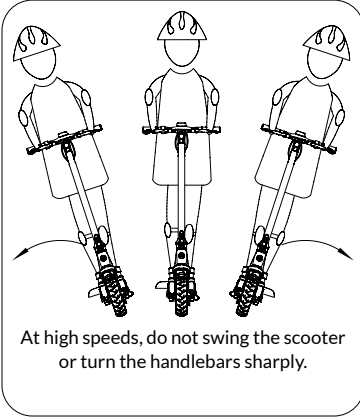

Cleaning:

Please never wash the scooter with a water hose!

To reliably prevent rust, it is recommended to thoroughly clean and dry the vehicle after driving in the rain. The use of rust inhibitors is strongly recommended.



Use suitable cleaning and care products and a soft sponge.

Never use solvents.

Never aim a direct jet of water at the following components: headlights, handlebar switches, brake levers, battery, charger.

After washing, wipe with clean water to remove any cleaning residue.

Dry with a leather cloth.

Attention:

Always make sure all cables and brake cables are working when outside temperatures are around freezing.

After cleaning, perform some braking operations in a place safe for traffic with extreme caution. The water on the braking surfaces will reduce the braking performance for a short time.

Please keep your **SCOTEX H10** away from sun and rain.

Regularly check the screws and small parts on your scooter. Do not use alcohol, gasoline, acetone or other chemical solvents to clean the scooter, as it may corrode. Pay attention to regular maintenance and inspection of the individual parts.

Battery maintenance and care is critical to the life of your battery. Incorrect maintenance, care and charging behavior can significantly reduce the service life and lead to irreparable damage and malfunctions.

Lubrication

Apply a little grease to the joints of the folding mechanism of the handlebar grips every 6 months. Check the vehicle regularly for loose screw connections.

Battery

The lithium polymer battery included in the package can be recharged at least 500 times. With normal use, maintenance and care, approximately 1,000 full charge cycles may be possible.

Storage and daily care

Do not park the scooter in the blazing sun or rain. Keep the vehicle clean and dry. Clean the scooter only with a soft cloth and without aggressive cleaning materials.

| Error code | Meaning |
|-------------------|----------------------------|
| 01E | Signal communication fault |
| 02E | Throttle fault |
| 03E | Battery fault |
| 04E | Motor fault |
| 05E | Controller fault |
| 06E | Hall fault |
| 07E | Brake lever fault |
| 10E | Battery protection |
| 11E | Battery short-voltage |
| 20E | Power button fault |
| 21E | Gear button fault |



When properly maintained and used (in accordance with the guidelines for loading and storage), the battery will have a normal life of two to three years. If the battery can not be recharged or charged properly, it should be removed from the Scooter and disposed of a recycling facility.

Federal laws prohibit the disposal of batteries in normal household waste.

Please contact your local waste or recycling authority for information in your area to recycle the battery.

Batteries or packaging for batteries are labeled in accordance with European Directive 2006/66/EC concerning batteries and accumulators and waste batteries and accumulators. The Directive determines the framework for the return and recycling of used batteries and accumulators as applicable throughout the European Union. This label is applied to various batteries to indicate that the battery is not to be thrown away, but rather reclaimed upon end of life per this Directive in accordance with the European Directive 2006/66/EC, batteries and accumulators are labeled to indicate that they are to be collected separately and recycled at end of life. The battery (Pb for lead, Hg for mercury, and Cd for cadmium). Users of batteries and accumulators must not dispose of batteries and accumulators as unsorted municipal waste, but use the collection framework available to customers for the return, recycling, and treatment of batteries and accumulators. Customer participation is important to minimize any potential effects of batteries and accumulators on the environment and human health due to the potential presence of hazardous substances.

Thank you for choosing one of our **SCOTEX H10**. You have a warranty of 24 months on your scooter from the date of purchase.

Please note that there is no warranty if:

The warranty period has expired.

If you do not have an invoice and your order has not been recorded in the system.

The SXT Scooter has not been used properly.

Technical modifications have been made to the SXT Scooter.

The SXT Scooter has been stored improperly.

The SXT Scooter has been damaged in an accident.

If a non-original charger has been used.

If the SXT Scooter has been damaged by contact with water.

If the SXT Scooter has been used in extreme temperatures.

No original spare parts and/or accessories have been installed.

In addition, wearing parts such as Tires and brake pads are not covered by the warranty.

Our customer service/technical support is available for all technical issues that are not listed in these operating instructions.



To avoid serious injury, repairs to the battery must only be carried out by trained personnel. If necessary, please contact your dealer or our technical support.

You can find all spare parts and accessories on www.sxt-scooters.de



CONTACT TECHNICAL SUPPORT

POL-Planet GmbH & Co. KG.

Marie-Curie Straße 2 • 79618 Rheinfelden

Tel: +49(0)7623-460 460 • Fax: +49(0)7623-460 46 49

info@scotex.de • www.scotex.de



SCOTEX®

BY SXT

POL-Planet GmbH & Co. KG.
Marie-Curie Straße 2 • 79618 Rheinfelden
Tel: +49(0)7623 460 460
info@scotex.de • www.scotex.de